



Orcas™ Ultrasonic Flowmeter

A portable flowmeter
designed for speed and ease

Instruction Guide

This device complies with Part 15 of FCC Rules and Industry Canada license-exempt RSS standard(s). Operation is subject to the following two conditions: (1) this device may not cause harmful interference, and (2) this device must accept any interference received, including interference that may cause undesired operation. Contains FCC ID: XDULE40-S2, Contains IC: 8456A-LE4S2. CAN ICES-1/NMB-1; CAN ICES-3 (B)/NMB-3(B) **MODEL: SWT ORCAS-01**

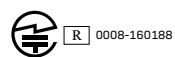

Contents

General Information

Page

General Information	4
Meter Features	4
Technology	5
Dimensions	5

Orcas App

App Features	6
App Installation and Setup	6
Getting Started	6
Location Setup	6
Parameter Setup	7

Flowmeter Installation

Straight Pipe Recommendations	8
Full Pipe Recommendations	9
Flowmeter Orientation	9
Transducer Spacing	10
Power Considerations	10
Installing the Flowmeter	11
Do's and Don'ts	11

Operation

Collecting Your Data	12
Data Logging	12
Making a Recording	13
Uploading Data	13
Saving Data	13
Explanation of Recording Time	14

Troubleshooting

Problems	15
Probable Causes	15
Things to Try	15

Orcas is a portable ultrasonic flowmeter designed for speed and ease of use. With the Orcas, you can capture accurate and reliable flow measurements in under one minute—saving you time and money.

There are no wires and no bulky electronics to haul around. Your mobile device connects wirelessly to display measurements. And, the ultrasonic flowmeter installs on the outside of your pipe. With Orcas Flowmeter & the Orcas App, you'll get your job done more quickly every time.

Industries

- 
Waterparks, Pools, and Aquariums
- 
Building Commissioning and Maintenance
- 
Agricultural Irrigation
- 
Building Water Management

Fast to install, easy to use.

SoundWater Advantages

MEASUREMENTS YOU CAN TRUST

Our proprietary SoundWater Reciprocity Architecture™ prevents zero-flow drift and eliminates the need for calibration, resulting in long-term measurement stability and accuracy.

INCREASES PRODUCTIVITY

Featuring compact lightweight construction and intuitive apps, our products reduce installation, training, and setup—saving you time and money.

MADE IN USA

Locally owned and operated out of Wenatchee, Washington, our products are built with American quality and ingenuity.

WORKS IN TOUGH APPLICATIONS

Our transducers auto-adjust ultrasonic power output depending upon pipe and fluid conditions—giving you more frequent measurements when things get tough (e.g., corroded pipe or murky fluid).

LONG LIFE / LOW MAINTENANCE

SoundWater products are built to last using the highest quality materials, gasketed & double O-ring seals, and silicone gel to protect electronics.

SERVICE & ACCOUNTABILITY

We establish long-term customer relationships based on trust and service. We will respond to your needs and requests within 24 hours.

Features

All Orcas models include the features shown below.

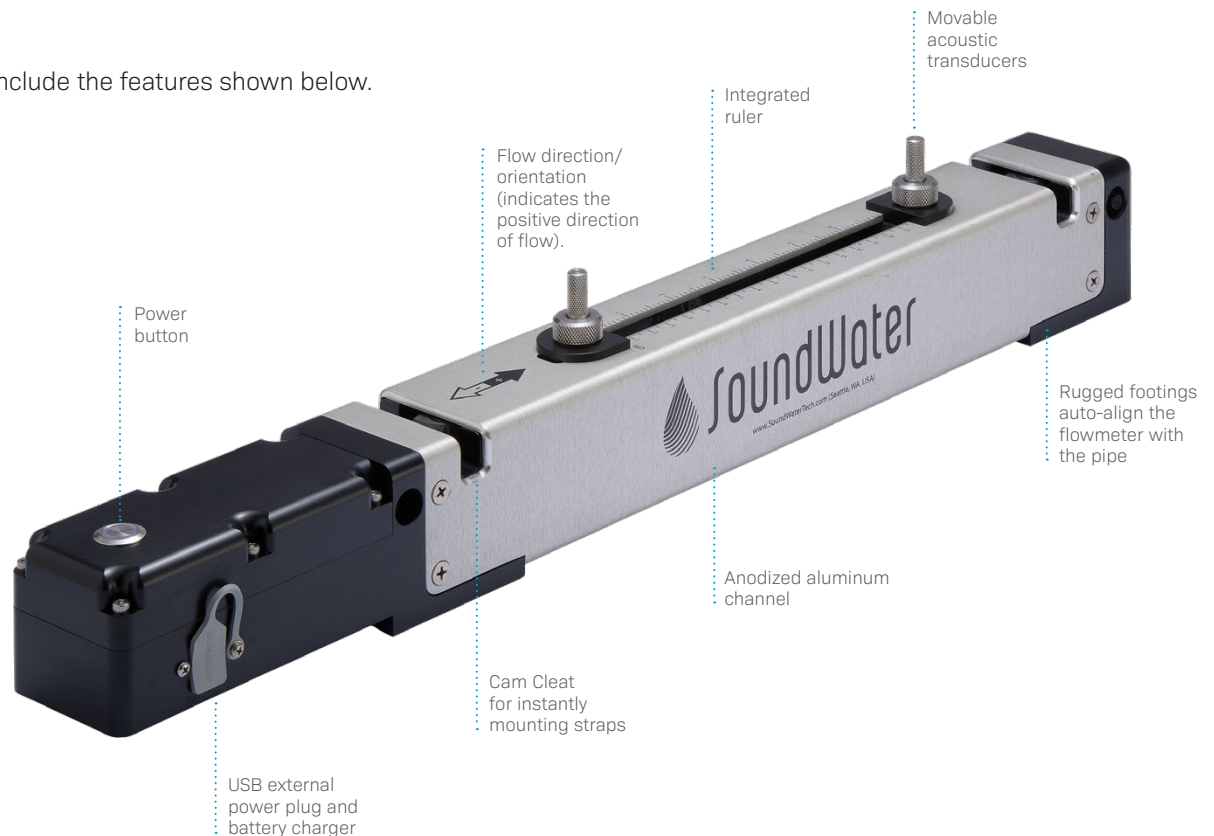

Technology

The transit time flowmeter operates by alternately transmitting and receiving a burst of sound energy between the two transducers. The burst is first transmitted in the direction of fluid flow and then against fluid flow.

Since sound energy in a moving liquid is carried faster when it travels in the direction of fluid flow (downstream) than it does when it travels against fluid flow (upstream), a difference in the travel times will occur. The sound's travel time is accurately measured in both directions and then used to compute the flow rate.



Dimensions

Orcas Txx-C5

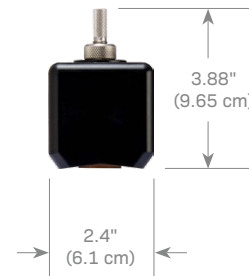

Orcas Txx-C7





Orcas Txx-C11







App Features

Interactive smartphone/tablet control app — iOS or Android.

-  Save location information
-  Handy built-in pipe specifications —or add your own
-  Drag and drop the measurements you want to see



-  English or metric units
-  English or Spanish language
-  Easy-to-use data logging
-  Select liner and liquid types —or define your own

App Installation & Setup

Getting Started

Begin by downloading the Orcas App to your iPhone™, Android phone, or other Bluetooth enabled mobile device from the Apple Store™ or Google Play™. (Note: On an iPad, you must select iPhone Only in the app store.) If you do not have automatic updates enabled on your device, be sure to update your app when notified that there is a new version available.



Orcas App

Standard Version

Works for all Orcas Products

NOTES:

- Be sure your Bluetooth is enabled, location services allowed, and that your device supports Bluetooth 4.0 (BT LE) or later.
- The following iOS devices support Bluetooth 4.0: iPhone 4S and later, iPad 3rd generation and later, iPad mini, iPad Air, and iPod Touch 5th generation.
- If you have an Android device, check the settings on the device or specifications for the device.

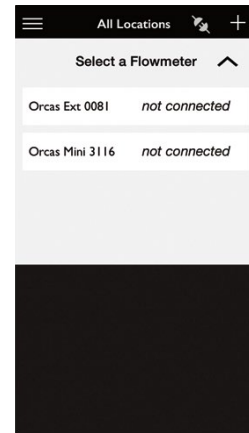

Connect Your Flowmeter

At launch the app will find any nearby Orcas flowmeters. Select the flowmeter you want to connect to from the list.

Location Setup

Launching the app lands you on the **All Locations** screen. The app always begins with this screen at launch, making it easy to access previously saved location settings.

Begin by tapping on the **Add Location (+)** button.

Give your location a name and then set the specific parameters for that location. Each location's settings are stored in the Orcas App, ready for reuse.

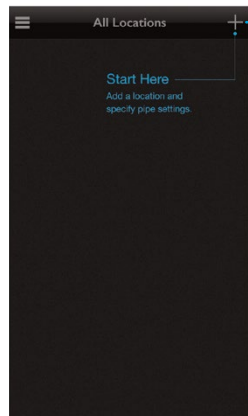

+ Add location

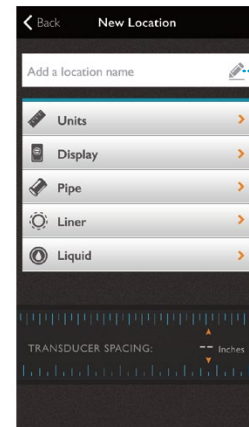

Name your location

Parameter Setup

Use the handy parameter selection screens to set your units of measure and display preferences.

Conveniently select pipe, liner, and liquid specifications from lists of pre-loaded values.

Don't see the right option?
Add your own custom values.

NOTE:

Required menus must be completed.

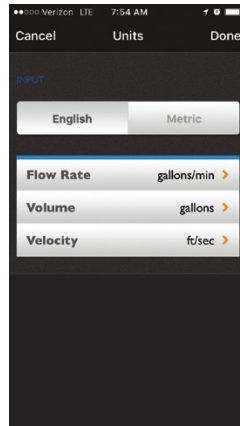

Units

Toggle between **English** and **metric** units of measure.

Select **Flow Rate**, **Volume**, and **Velocity** from our pre-loaded values.

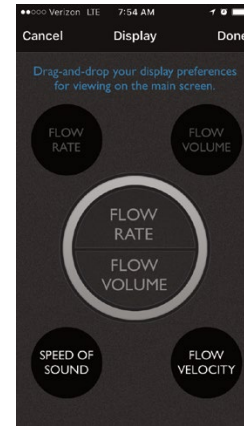

Display

The main screen displays two measurement types. Drag and drop the two measurements that you want to see on the screen.

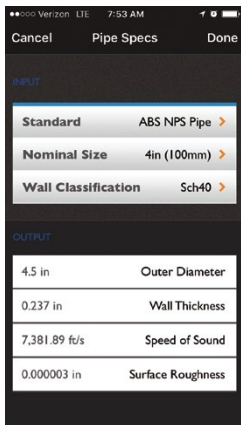

Pipe

Select **Pipe Type**, **Size**, and **Wall Classifications** from our pre-loaded values or add custom values by selecting Custom under Pipe Type. When entering a custom type, you must supply the outer diameter, wall thickness, speed of sound through the pipe material, and the surface roughness—enter zero if roughness is unknown.

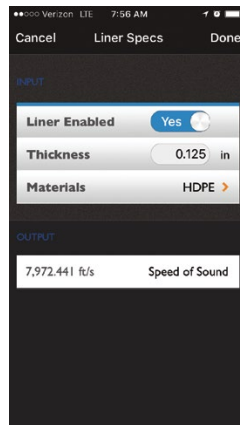

Liner

Switch between liner and no liner. When selecting **Liner Enabled**, enter **Liner Thickness** and choose **Liner Material** from our pre-loaded list or add custom values. When adding a custom material, you must enter the speed of sound through that material.

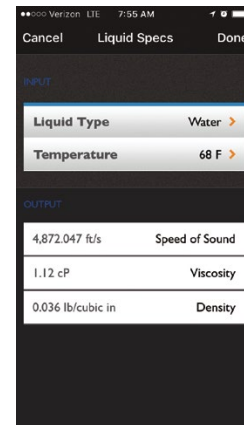

Liquid

Select **Liquid Type** and **Temperature** from our pre-loaded list of values or add a custom liquid type. When adding a custom liquid, you will need to enter the speed of sound through that liquid, the viscosity, and the density.

Flowmeter Installation

Straight Pipe Recommendations (X = diameter)

Reduced Pipe

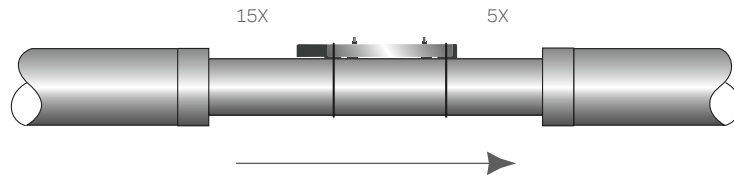

Two Elbows In Plane

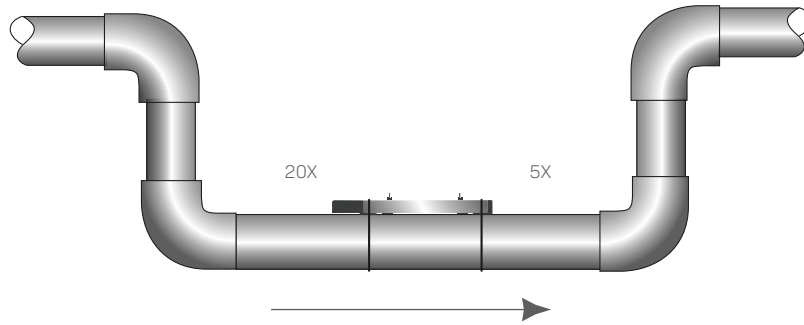

Two Elbows, Out Of Plane

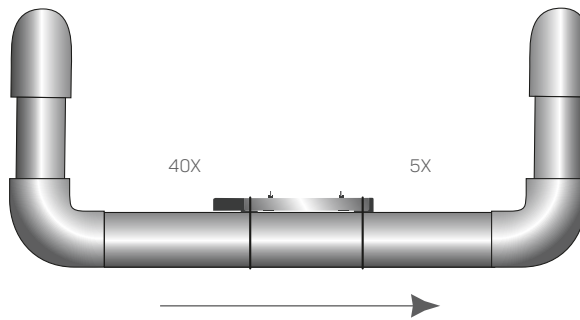

Expanded Pipe

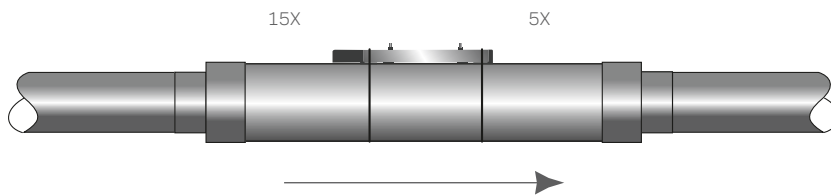

Swirling Flow:
Propeller Meter

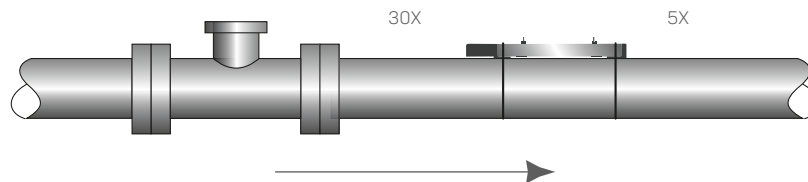

Swirling Flow:
Partially Open
Butterfly Valve

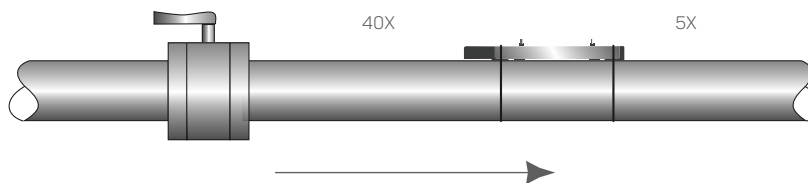

Full Pipe Recommendations

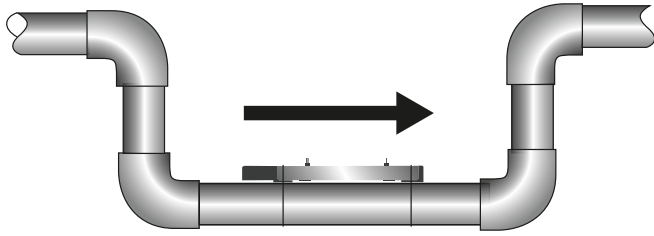

RECOMMENDED:

Keeps pipe full at meter for accuracy

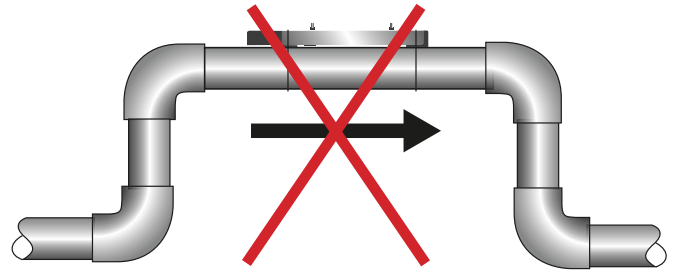

NOT IDEAL:

Allows air pockets to form at meter

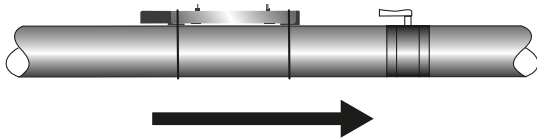

RECOMMENDED:

Keeps pipe full at meter for accuracy

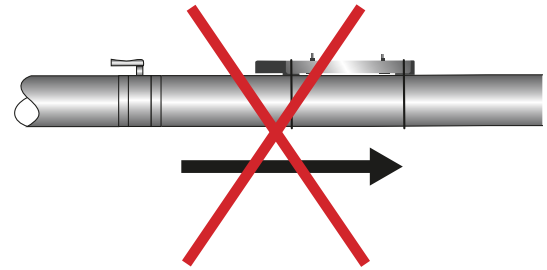

NOT IDEAL:

Post-valve cavitation can create air pocket

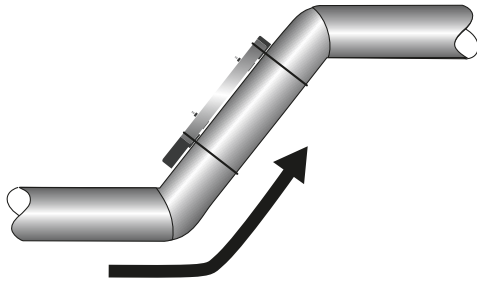

RECOMMENDED:

Allows air to bleed off

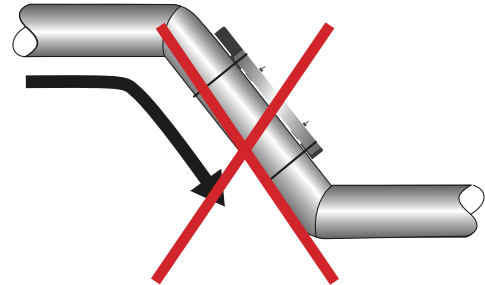

NOT IDEAL:

Air can be trapped

Flowmeter Orientation

This is a view looking directly into a horizontal pipe, with the meter in multiple possible positions on the side of the pipe.

Horizontal (3 o'clock or 9 o'clock position) is the preferred installation orientation, since it avoids problems with trapped air and sediment.

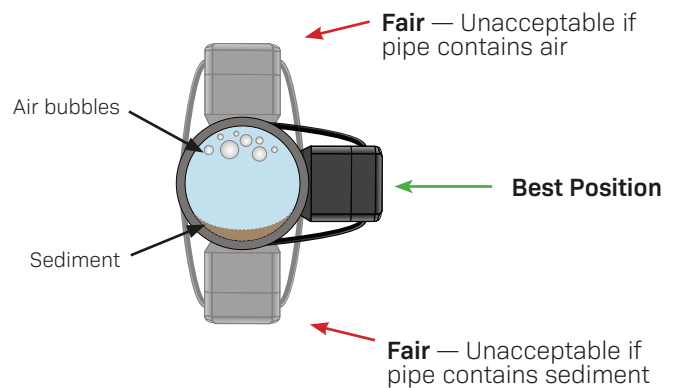

Transducer Spacing

Once you entered your parameters in the previous section, the app automatically computed the proper transducer spacing. This is shown at the bottom of the main app screen.

The next step is to adjust the transducer spacing on the flowmeter as follows:

1. Rotate the short-wide stainless steel knob to unlock the horizontal motion for each transducer.
2. Move the transducers to the specified transducer spacing by sliding them along the integrated ruler. **NOTE:** It is not necessary to start at zero on the ruler as long as the actual spacing is correct.
3. Lock into place using the short-wide stainless steel knobs. This is important to prevent the transducer spacing from moving when mounting the flowmeter!

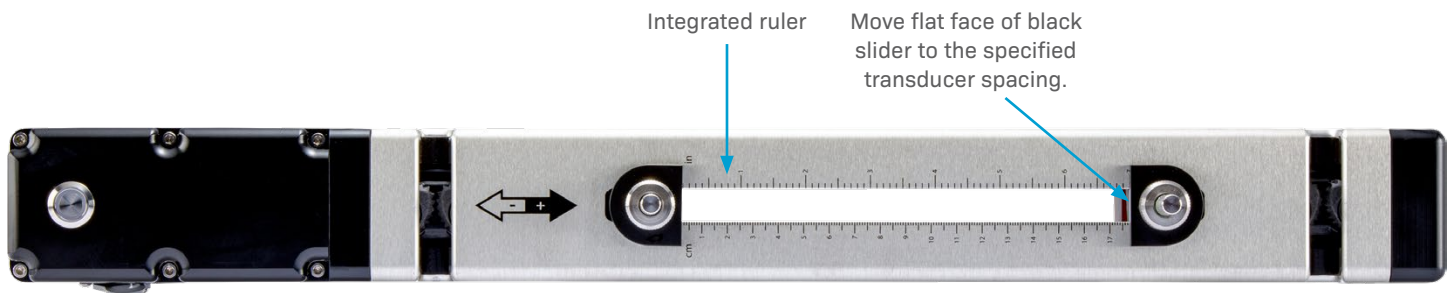
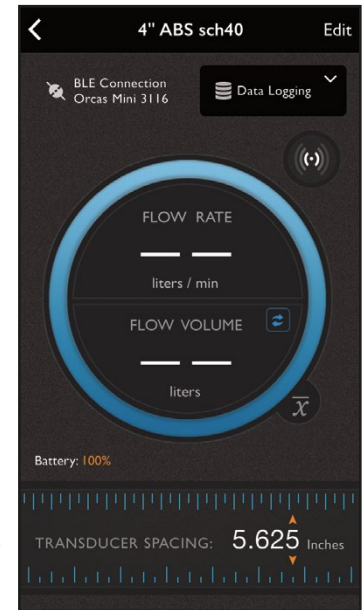

Power Considerations

Your Orcas Flowmeter battery **does not** come fully charged. Fully charge before set up. When it's time to recharge the battery, the app will let you know.* When it's time to recharge the battery, the app will let you know.

The flowmeter's LED light will flash while charging and will turn itself off when complete. To maintain the life and health of your battery, be sure to allow the flowmeter to complete full charge cycles, i.e., continue charging until the LED stops flashing and the flowmeter automatically turns itself off.

When using the data logging function and **recording for more than 24 hours, the Orcas must be connected to a power source**, such as a portable USB power bank or a USB power adapter connected to an external power source.

* On a full charge, the Orcas will have a shelf life of up to five months. It is a good idea to charge the unit for a full five hours if it hasn't been used for a month or two. On a full charge the meter should operate for up to 24 hours of continuous use. Note that if the battery is discharged, the power button LED will blink rapidly for five seconds and then the meter will turn off.

All domestic and international shipments containing lithium-ion batteries are subject to transport regulations on hazardous goods according to ADR RID, ADN, IMDG, ICAO / IATA Regulations. This product is classified as UN3841. It is your responsibility to observe these regulations.



When recording more than 24 hours, the Orcas must be connected to an external power source, such as the USB power adapter supplied with the Orcas.

Installing the Flowmeter

Once the transducer spacing has been set and locked in place, you are ready to install the flowmeter on your pipe.

1. Rotate the tall, thin stainless knobs counter clockwise until they stop. This raises the transducers up above the meter footings.
2. Apply coupling gel liberally to the transducer faces, covering the entire bottom face of each transducer.
3. Place flowmeter on pipe, assuring that the footings are flush with the pipe and the meter is aligned with the axis of the pipe.

4. Strap the meter to pipe with the mounting straps, clamping the straps into the cam cleats. Hand tighten only!
5. Rotate the tall, thin knobs clockwise to press transducers onto the pipe. Hand tighten only until seated firmly.
Warning: Tightening too much can lift the meter away from the pipe, causing incorrect readings.

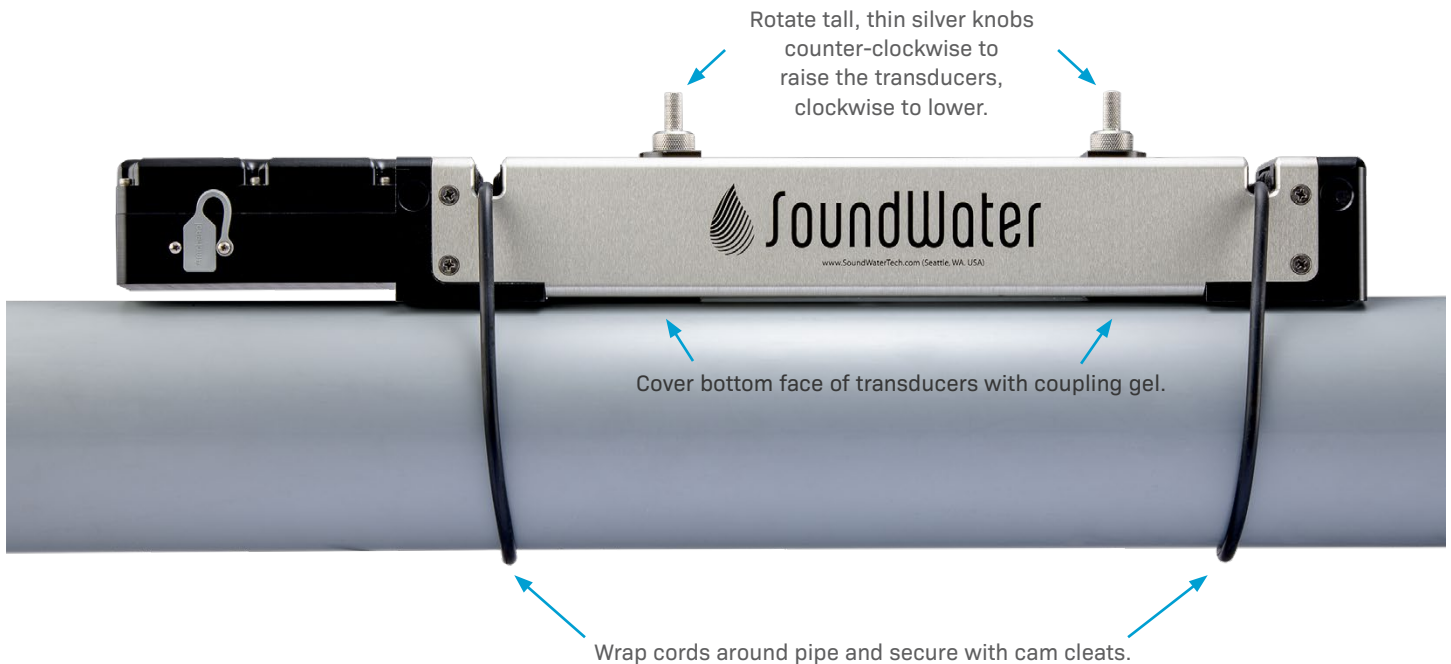

Do's and Don'ts

- Do** charge your Orcas at least once a month.
- Do** allow the flowmeter to complete full charge cycles until the LED stops flashing and the flowmeter automatically turns itself off.
- Do** store your Orcas in a dry, indoor area when not in use.
- Do** store your Orcas fully charged.
- Do** keep your Orcas in its protective case when transporting to prevent damage.
- Do** gently clean the transducer pads regularly with isopropyl alcohol to prevent hardening and build up of used coupling gel.

- Don't** charge with any charger other than the 12W charger supplied. Other chargers may damage the Orcas.
- Don't** operate on incomplete charge or interrupt battery charging cycles.
- Don't** store, transport, or use your Orcas where the device may exceed 185°F (85°C)—battery may leak or explode!
- Don't** bang or drop the Orcas on hard objects or surfaces.
- Don't** nick the transducer pads.

Operation

Collecting Your Data

1. Be sure the app is running on your mobile device.
2. Turn on power to the flowmeter by pressing the power button on the left top of the meter. A steady LED indicates that power is on. The LED will flash if the meter is charging on external power.
3. The app will display a list of all Orcas meters within its range. Tap the one you are currently using.

Note: Your app will check the flowmeter to be sure it has the most recent programming. If there is a newer version available, it will give you the option of updating the meter. Updating the meter may take three to five minutes.

4. Your flow data will display on the Orcas App. →
5. When you are done collecting data, snap the cords out of their cam cleats and you are ready to move on to your next location. The next time you return to this location, the Orcas App will remember your settings.

Power button →



Data Logging

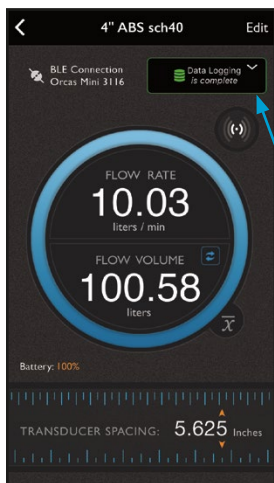

The purpose of the Orcas's built-in data logger is to record flow for a specified period of time. It may be used to conveniently record flow for as long as 365 days, 10,000 measurements, or 50,000 datapoints or as little as one minute.

While conveniently battery powered, the Orcas has limited memory. Thus, only one data log may be used at any one time. As the Orcas data logger uses Bluetooth (BLE) to transfer data from the flowmeter to the mobile device, data transfer speed is limited by BLE, which is not designed to transfer large data sets. Transferring the maximum sized data set will take up to 5 1/2 minutes.

All data logging functions are accessed by tapping the **Data Logging** button in the measurement view.



The Orcas's data logger stores only one data set at any time, selecting "REC" (which creates a new data log) will write over the existing data log. A message appears when selecting the "REC" button indicating that the existing data log will be over-written if a new data log is started and gives the user the ability to continue with the new data log or to cancel.

Making a Recording

- Connect to the meter with the Orcas App.
- Tap the **Data Logging** button to access the data logger features.
- Using the slider bar in the app's data logger setup view, set the recording time. (See Explanation of Recording Times on the next page.)
- Tap **"REC"** to start the recording. Data will start recording on the meter. You can disconnect the mobile app during recording. The meter will turn off when done to save power, unless still connected to the app.
- To stop recording prior to completing the time period, connect the Orcas App to the meter, tap the Data Logging button, and tap **"STOP."**

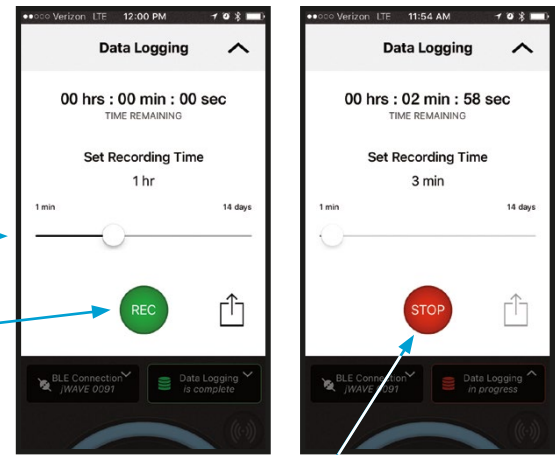

The status of the data logger is indicated by the color and text of the data logger setup button, located in the measurement view. If data logger is active, the button is outlined in red, shows a red disk drive, and displays the text "in progress." If the data logger is completed, the button is outlined in green, shows a green disk drive, and displays the text "complete." The data logger setup view also displays the remaining recording time for conveniently checking progress of data logging.

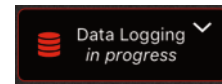

Active data logging session running.

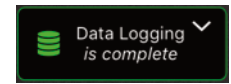

Data logging session complete.



Upload data by tapping the "Share" button.

Uploading Data

Data is stored on the flowmeter and may be retrieved at any time. To upload data, the data logger must be either complete or stopped and the app must be connected to the flowmeter. Data is uploaded using the "Share" button located to the right of the "REC" button. Uploading the maximum sized data set may take up to 5 1/2 minutes.

If you want to quickly review your data at any time, tap the "share" button, and then tap Quick Look (iOS devices). This displays the data log in a spreadsheet for immediate viewing on your mobile device.

Sharing Data

You only need to upload the data log once from Orcas. Once the data is uploaded, it may be shared any number of times without additional uploading until a new data log is started.

Tap the "Share" button to share the data by a number of methods: email, text, AirDrop, etc. Shared data is formatted in a CSV file (comma delimited file). The file name is unique and contains both the date and time that the data log was started as well as the location name. Setup information such as the date and time the data log was started, the number of samples, sampling period, and location name are located at the top of the data file.

The data is arranged in rows, where each row contains a single flow measurement including sample number, time stamp, flow rate, velocity, volume, and quality. The data file can be viewed or printed as a text file or formatted using most spreadsheet and database programs, such as Microsoft® Excel or Access.

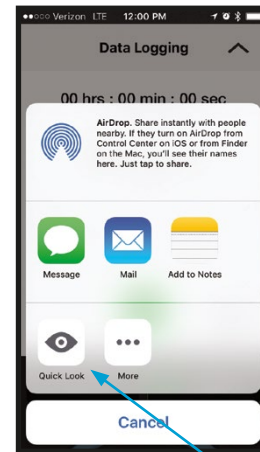

sample number	time (hrs:min:sec)	flow rate (gallons/min)	flow vol
1	00:00	0.1171	0.1171
2	00:04	0.1172	0.2343
3	00:08	0.1173	0.3516
4	00:12	0.1171	0.4687
5	00:16	0.1170	0.5857
6	00:20	0.1171	0.7028
7	00:24	0.1172	0.8200
8	00:28	0.1173	0.9373
9	00:32	0.1171	1.0544
10	00:36	0.1170	1.1714
11	00:40	0.1171	1.2885
12	00:44	0.1170	1.4055
13	00:48	0.1171	1.5226
14	00:52	0.1172	1.6396
15	00:56	0.1173	1.7571
16	01:00	0.1171	1.8742
17	01:04	0.1171	1.9913
18	01:08	0.1172	2.1085
19	01:12	0.1173	2.2256
20	01:16	0.1171	2.3429

Tap **"Quick Look"** for immediate viewing of your data.



NOTE:
The app must be connected to the Orcas in order to share the data or view it with Quick Look.

Explanation of Recording Time

The sampling period (time between recorded flow measurements) and total number of recorded measurements (samples) is controlled by Orcas. The maximum number of measurements that can be recorded is 10,000, where each measurement includes five data points (flow rate, velocity, total volumetric flow, time, and measurement quality). The minimum sampling period is 5 seconds, or in other words, the fastest sampling rate is 12 samples/minute.

The Orcas data logger will minimize the sampling period based on your selected recording time (i.e., maximize the number of measurements). For example, if you select to record flow for one minute, then the Orcas will set the sampling period at its minimum of 5 seconds and will record 12 flow measurements (covering a total of 60 seconds). If you record flow for 30 days, then the Orcas again will maximize the number of flow measurements. However, recording flow every 5 seconds for 30 days will exceed 10,000 measurements, so the Orcas will increase the sampling period to 260 seconds (30days /10000) to record 10,000 measurements.

Recording Time	Sample Period
1 minute	5 seconds
1 hour	5 seconds
10 hours	5 seconds
1 day	9 seconds
10 days	86 seconds (1 min. 26 sec.)
1 month	260 seconds (4 min. 20 sec.)
6 months	1577 seconds (26 min. 17 sec.)
12 months	3154 seconds (55 min. 34 sec.)



When recording more than 12 hours, the Orcas must be connected to an external power source, such as the USB power adapter supplied with the Orcas.

Troubleshooting

Problem	Probable Causes	Things to try...
Battery not charging	Using wrong power supply	Use the supplied 12W charger/power supply
	Incomplete battery charge	Allow the flowmeter to complete full charge cycles until the LED stops flashing and the flowmeter automatically turns itself off
No signal	Incorrect setup	Confirm pipe settings
	Air in pipe	Rotate meter to 3 o'clock position Remove air Relocate meter to another location where there is no air
	Corroded rusty pipe	Relocate meter to clean section of pipe. If no clean section is available, move meter to other locations until a signal is found—try to find a section of pipe with less corrosion or rust. Older steel and ductile iron pipes may be heavily corroded, which can prevent ultrasound transfer and flow measurements. For these types of applications, SoundWater has a special transducer configuration that helps to penetrate corrosion, making flow measurement possible. Please contact us to discuss your application and how to select the best transducer.
Orcas App not displaying any flowmeters to connect	Bluetooth not enabled	Open your iOS or Android system settings and enable Bluetooth. Quit and relaunch the Orcas App. Orcas App is compatible only with Bluetooth 4.0 (or later), also known as Bluetooth LE, or Bluetooth Low Energy. Most mobile devices are BLE enabled; however some older devices may use standard Bluetooth and may not be compatible.
	Location Services not enabled	Open your iOS or Android system settings and enable locations services for the Orcas App.



1-509-899-7838



sales@soundwatertech.com



support@soundwatertech.com



soundwatertech.com